

dimensioni | dimensions

	UM	Valore Value
A	mm	2400

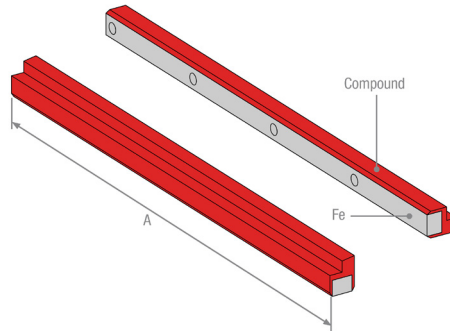

specifiche tecniche | technical specifications

	um	norme norms	valore value
materiale material			PU
superficie A surface A			inclinata
superficie B surface B			senza rivestimento

specifiche mescola | compound specifications

	um	norme norms	valore value
colore color			rosso red
polimero base base polymer			PU
durezza hardness	SH/A	ISO 7619-1	80
peso specifico specific weight	g/cm ³	ISO 2781	1,24
carico di rottura tensile strength	N/mm ²	ISO 37-1	24
allungamento a rottura elongation at break	%	ISO 37-1	489
perdita abrasione abrasion loss	mm ³	ISO 4649	52
resistenza alla lacerazione tear resistance	N/mm	ISO 34-1 - Metodo B	35